

Agilent 4395A 500 MHz Network/Spectrum/ Impedance Analyzer

Agilent 4396B 1.8 GHz Network/Spectrum/ Impedance Analyzer

Awareness Brochure

New Approach to Electronic Component and Circuit Evaluation

A new concept in testing that combines the power of a vector network analyzer, a spectrum analyzer, and an optional impedance analyzer.

Take an innovative approach to evaluating electronic components and circuits. The Agilent Technologies combination analyzers family combines three analyzer functions in one powerful instrument: a vector network analyzer, a spectrum analyzer, and an optional impedance analyzer. Now you can use one analyzer for multiple testing needs.

Because many electronic components such as amplifiers require both vector network and spectrum parameters, you need a combination analyzer to meet new testing requirements such as:

- Measuring intermodulation distortion and phase performance of components used in digital communication systems.
- Characterizing monolithic IC's or circuit blocks.

Compared with using separate analyzers, you save equipment cost and bench space with the Agilent 4395A/96B, and avoid time-consuming and messy signal cabling to multiple instruments.



Agilent Technologies

Innovating the HP Way

Introducing the Agilent 4395A

An Integrated Solution Delivering Exceptional Performance and High Value to 500 MHz

Color TFT (Thin Film Transistor) LCD with Dual Display

- Split-screen viewing for two independent channels
- VGA output for external monitor

Three Analyzer Functions give you maximum flexibility. Jump from one type of measurement to another with the push of a button.

Two independent channels provide flexibility

- Test both parameters in your selected analyzer mode (vector network, spectrum, or optional impedance)
- Get real-time data through fast alternate sweeps

Markers highlight key data points quickly:

- Up to eight markers per channel
- Delta marker
- Marker zoom
- Peak search, peak all, marker analysis functions and more

Powerful Calibration/ Compensation

Vector network and high sensitive spectrum input ports offer:

- R, A, B ports for transmission and reflection measurements
- R, A, B ports for high sensitivity spectrum measurements
- 75 Ω impedance conversion (Opt. 1D7)

Fast Sweep improvements throughout

DC Source (Opt. 001)

1.44 MB Floppy Disk Drive lets you save and recall in either LIF or MS-DOS® format:

- Test setups
- Calibration data
- Measurement data
- IBASIC programs
- Graphic (TIFF) files

Test sets and accessories give you measurement options in 50 Ω or 75 Ω

- Agilent 87511A/B S Parameter Test Set

Synthesized source for network/impedance analysis provides:

- 1 mHz and 0.1 dB resolution
- 2- to 801-point sweep
- High-stability frequency reference (Opt. 1D5)

Optional impedance analysis:

- Option 010 adds impedance measurement function
- Agilent 43961A RF impedance test kit

Agilent IBASIC adds these capabilities:

- Test automation
- External instrument control through GPIB or digital I/O port
- Programming from an external keyboard
- Keystroke recording
- Customizing test setups for adjacent channel power and occupied bandwidth measurements.
- Data analysis
- IBASIC program One Key Execution Function

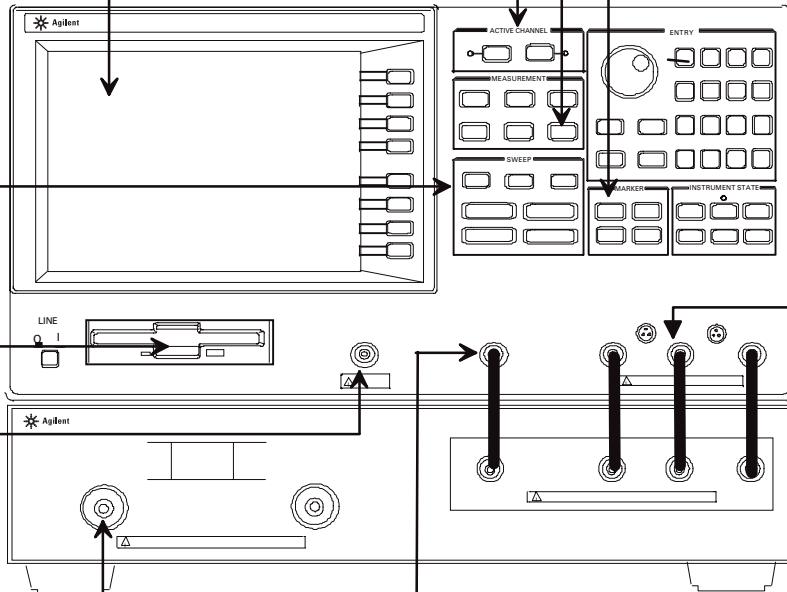

Introducing the Agilent 4396B

An Integrated Solution Delivering Exceptional Performance and High Value to 1.8 GHz

Color TFT (Thin Film Transistor) LCD with dual display

- Split-screen viewing for two independent channels
- VGA output for external monitor

Three analyzer functions give you maximum flexibility. Select the type of measurement with the push of a button.

Two independent channels provide flexibility

- Test parameters in either vector network, spectrum, or optional impedance
- Get real-time data through fast alternate sweeps

Markers highlight key data points quickly:

- Up to eight markers per channel
- Delta marker
- Marker zoom
- Peak search, Peak all, and more

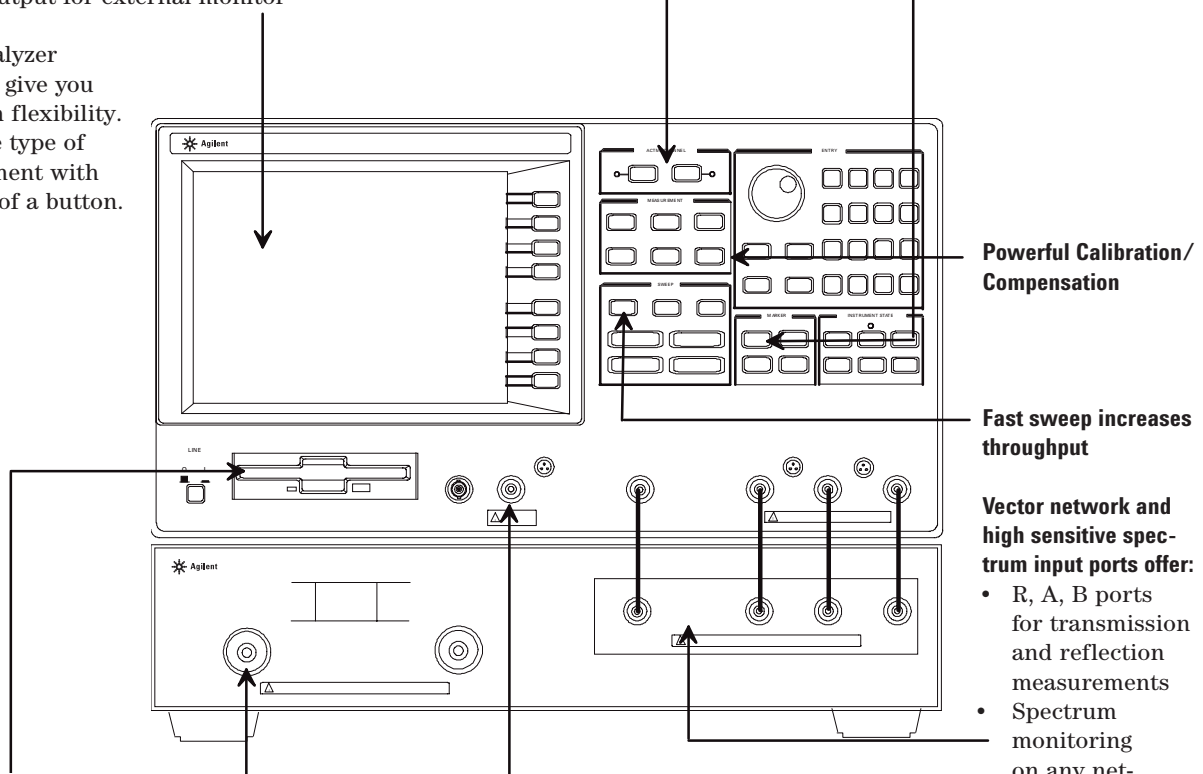

Powerful Calibration/Compensation

Fast sweep increases throughput

Vector network and high sensitive spectrum input ports offer:

- R, A, B ports for transmission and reflection measurements
- Spectrum monitoring on any network port

1.44 MB Floppy Disk Drive lets you save and recall in either LIF or MS-DOS® format:

- Test setups
- Calibration data
- Measurement data
- IBASIC programs
- Graphic (TIFF) files

Spectrum analysis input port

- High Sensitivity
- 75 Ω impedance conversion (Opt. 1D7)

Synthesized source for network/impedance analysis provides:

- 1 mHz and 0.1 dB resolution
- 2- to 801-point sweep
- High-stability frequency reference (Opt. 1D5)

IBASIC adds these capabilities:

- Test automation
- External instrument control through GPIB or digital I/O port
- Programming from an external keyboard
- Keystroke recording
- Customizing test setups for adjacent channel power and occupied bandwidth measurements
- Data analysis

Test sets and accessories give you measurement options in 50 Ω or 75 Ω :

- Agilent 85046A/B S Parameter Test Set

Optional impedance analysis:

- Option 010 adds impedance measurement function
- Agilent 43961A RF impedance test kit

Exceptional Performance for Design and Manufacturing

In the lab, evaluate your designs completely and accurately with one instrument. The Agilent 4395A and the Agilent 4396B reduce learning and testing time so you get precision measurements with improved efficiency.

On the production line, increase your throughput with the combination analyzer. A combination analyzer makes it faster and easier to switch between different types of tests. You can optimize production testing with these capabilities:

- High test speed for vector network analysis
- Fast narrow-band spectrum analysis with stepped FFT
- List sweep
- Limit lines
- Test automation with built-in IBASIC

The analyzer's small footprint saves valuable bench space in any environment.

The Agilent combination analyzers family, a full-capability combination analyzer, makes no trade-offs among vector network, spectrum, and impedance performance. The spectrum analyzer function is based on digital signal processing (DSP) technology to speed measurement computation. It is a breakthrough in test instruments, giving you outstanding performance at an attractive price.

Make all of the following measurements with the Agilent 4395A/96B:

Vector Network Analysis

Attenuation
Bandwidth
Center Frequency
Complex Impedance
Cross Talk/Isolation
Directivity
Flatness
Frequency Response
Gain/Loss
Gain Compression
Group Delay
Insertion Loss
Linearity
Phase
Reflection Coefficient
Return Loss
Ripple
Rolloff
VSWR

Spectrum Analysis

Adjacent Channel Power¹
Carrier-to-Noise
Flatness
Frequency
Harmonic Distortion
Intermodulation Distortion
Linearity
Noise
Occupied Bandwidth¹
On/Off Ratio
Phase Noise
Power
Sensitivity
Spurious
Sidebands

Impedance Analysis²

Impedance ($|Z|$)
Admittance ($|Y|$)
Phase (θ)
Resistance (R)
Reactance (X)
Conductance (Γ)
Susceptance (B)
Capacitance (C)
Inductance (L)
Dissipation Factor (D)
Quality Factor (Q)
Reflection Coefficient (Γ)

Optional: Burst-signal Analysis (Opt. 1D6)

1. With IBASIC
2. With Option 010 and Agilent 43961A

Major Specifications

Agilent 4395A

Network Analyzer Specification		Spectrum Analyzer Specification		Impedance Analyzer Specification ²	
Frequency Range	10 Hz to 500 MHz ¹	Frequency Range	10 Hz to 500 MHz	Frequency Range	100 kHz to 500 MHz
Frequency Resolution	1 mHz	Noise Sidebands	<-104 dBc/Hz typical at 10 kHz offset	Meas. Parameter	Z , θ_z , R, X, Y , θ_y , G, B, Cs, Cp, Ls, Lp, Rp, Rs, X, D, Q, Γ , Γ_x , Γ_y
Output Power Range	-50 to 15 dBm	Resolution Bandwidth	1 Hz to 1 MHz in 1-3-10 steps	Z Accuracy	±3% (typical, basic accuracy)
Dynamic Range	115 dB @10 Hz IFBW	Dynamic Range	>100 dB third-order free dynamic range	Source Level	-56 dBm to +9 dBm (at DUT)
Dynamic Accuracy	±0.05 dB/0.3 deg.	Level Accuracy	±0.8 dB @50 MHz	DC Bias	±40 V (20 mA(max)) (Opt. 001 DC source or external DC source is required.)
Calibration	full two-port	Sensitivity	-145 dBm/Hz @freq. = 10 MHz	Compensation	OPEN/SHORT/LOAD Port Extension

Standard Features: Instrument BASIC, GPIB port, 3.5" floppy disk drive, direct print, RAM disk, VGA Monitor Output.

Optional Features: Impedance measurement (Opt. 010), Time-Gated Spectrum Analysis (Opt. 1D6), High-Stability Frequency Reference (Opt. 1D5), 50 Ω to 75 Ω Spectrum Input Impedance Conversion (Opt. 1D7), DC Source (± 40 V, 100 mA (ALC)) (Opt. 001).

1. 100 kHz to 500 MHz if using the Agilent 87511A/B S-parameter test set.

2. With Option 010 and the Agilent 43961A RF impedance test kit

Agilent 4396B

Network Analyzer Specification		Spectrum Analyzer Specification		Impedance Analyzer Specification ²	
Frequency Range	100 kHz to 1.8 GHz ¹	Frequency Range	2 Hz to 1.8 GHz	Frequency Range	100 kHz to 1.8 GHz
Frequency Resolution	1 mHz	Noise Sidebands	<-113 dBc/Hz typical at 10 kHz offset	Meas. Parameter	Z , θ_z , R, X, Y , θ_y , G, B, Cs, Cp, Ls, Lp, Rp, Rs, X, D, Q, Γ , Γ_x , Γ_y
Output Power Range	-60 to 20 dBm	Resolution Bandwidth	1 Hz to 3 MHz in 1-3-10 steps	Meas. range	2 Ω to 5 k Ω
Dynamic Range	>120 dB @10 Hz IFBW	Dynamic Range	>100 dB third-order dynamic range	Z Accuracy	±3% (typical, basic accuracy)
Dynamic Accuracy	±0.05 dB/0.3 deg.	Overall Level Accuracy	<±1.0 dB	Source Level	-66 dBm to +14 dBm (at DUT)
Calibration	full two-port	Sensitivity	<-147 dBm/Hz @freq. = 1 GHz	DC Bias	±40 V (20 mA(max)) (External DC bias source is required.)
				Compensation	OPEN/SHORT/LOAD Port Extension

Standard Features: Instrument BASIC, GPIB port, 3.5" floppy disk drive, direct print, RAM disk, VGA Monitor Output.

Optional Features: Impedance measurement (Opt. 010), Time-Gated Spectrum Analysis (Opt. 1D6), High-Stability Frequency Reference (Opt. 1D5), 50 Ω to 75 Ω Spectrum Input Impedance Conversion (Opt. 1D7).

1. 300 kHz to 1.8 GHz if using the Agilent 85046A/B S-parameter test set.

2. With Option 010 and the Agilent 43961A RF impedance test kit.

Component Analysis for Today and the Future

Modern digital communication systems require high linearity of signal transmission. To meet this new requirement, electronic components must have well-characterized phase and magnitude performance. Spectrum measurements, such as intermodulation distortion, are key to achieving high system quality. Also impedance measurements are very important to develop the high quality design.

The Agilent 4395A/96B keeps up with your new demands by offering the capabilities you need in an easy-to-use instrument. Eliminate the extra work and cost associated with using multiple instruments. Follow these simple steps to test your components:

- Easily alternate between vector network and spectrum measurements.
- See two measurement parameters on the dual-display color TFT LCD.
- Use powerful marker functions and up to eight markers per channel for data searching.
- Save and recall calibration data, measurement data, and test programs with either internal RAM disk or floppy disk.
- Easily dump data directly from the analyzer to the centronics printer.

Amplifiers

Make both linear and non-linear measurements with the Agilent combination analyzer. You get wide dynamic range for accurate intermodulation distortion measurement.

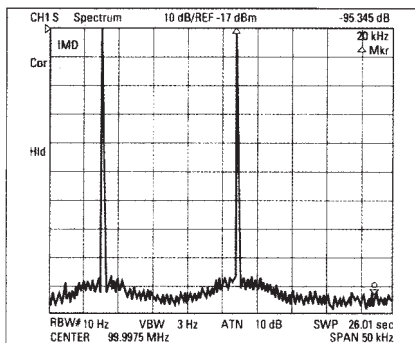
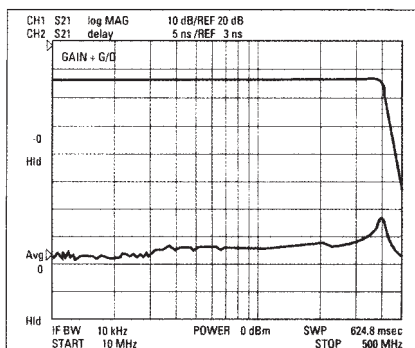

Mixers

Measure mixer output easily with Peak All and Market List. Measure conversion signals for distortion and harmonics.

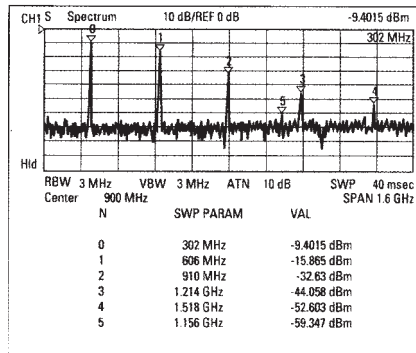

Oscillators

Predict oscillator stability by measuring the reflection coefficient in the vector network mode. Turn to the spectrum mode to see oscillation frequency, harmonics, and noise. Use Marker Zoom for measuring output level.

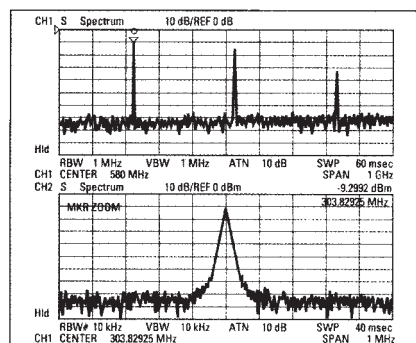
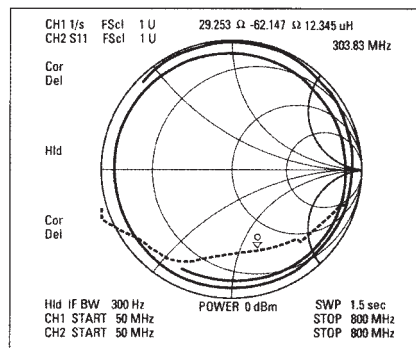

Filters

Characterize passband, stopband, group delay, and phase:

- Wide dynamic range. ± 0.05 dB/ ± 0.3 deg. gain/phase dynamic accuracy.
- Real-time tuning.
- High-stability frequency reference (Opt. 1D5) for narrowband and high Q devices.

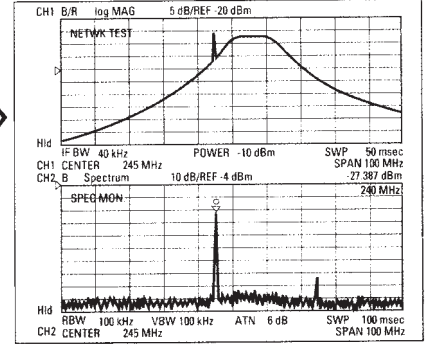
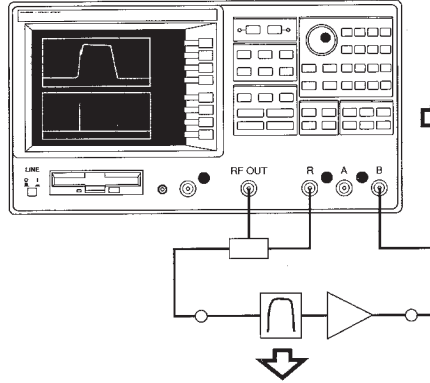

Agilent 4396B Network/Spectrum Simultaneous Measurement

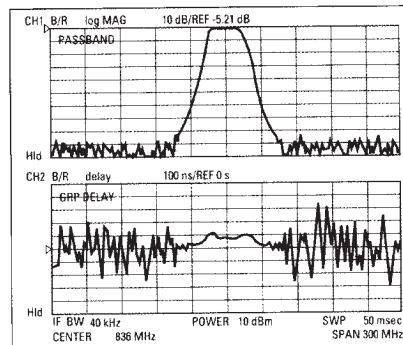
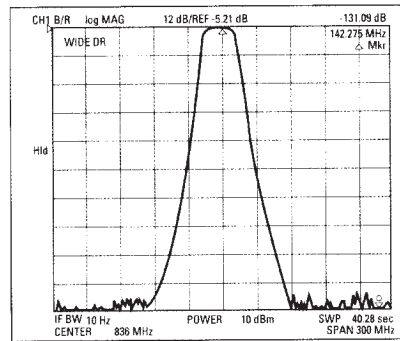

Two independent channels

With the Agilent 4395A, you determine the analyzer type (network, spectrum, or impedance) first, and then you can define each channel's parameters under your selected analyzer type. Using the 4396B, you can define analyzer type for each channel independently. So if you see any unusual frequency response while making a network measurement on the Agilent 4396B, you can quickly switch to spectrum monitoring (source will be turned off) to identify spurious signals without changing DUT connection on the color LCD with dual display as shown in figure.

Precision Spectrum Analysis with Improved Speed and Accuracy

Accurate signal monitoring is critical for designing quality products. In today's competitive environment, you need better spectrum measurement capabilities to stay ahead of the competition. The Agilent 4395A/96B, designed with new digital techniques, outperforms traditional analog spectrum analyzers.

- Improve testing speed up to 100 times for narrow RBW sweep. The analyzer's stepped FFT technique (4395A: all RBWs, 4396B: RBW ≤ 3 kHz) breaks the speed barrier to give you lower noise floor without sacrificing speed.
- Fully synthesized source.
- 1 Hz RBW with 3:1 shape factor for close-in signals.

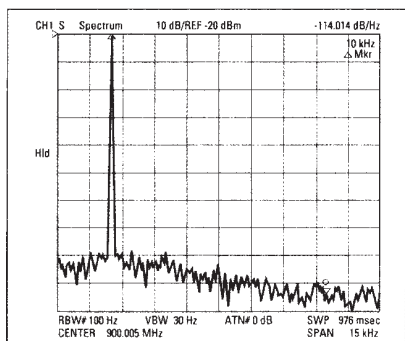

Sweep Time Comparison at 100 kHz Span and 100 Hz RBW

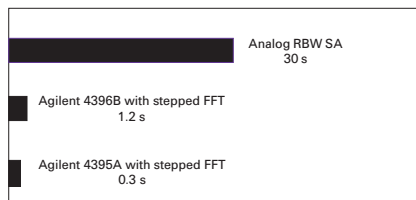

Get dramatic speed improvement, with no loss of accuracy, for narrow RBW sweeps. In addition, low phase noise provides improved signal resolution.

List sweep function can be used in not only network and impedance analysis, but also in spectrum analysis. List sweep separates the sweep frequency range into segments, and each segment can have an independent frequency range, number of sweep points, RBW, and power level settings. By using list sweep function, separate frequency bands can be measured in one sweep, or different RBW can be set for harmonics, IMD, and wide dynamic range measurements can be done in a shorter time.

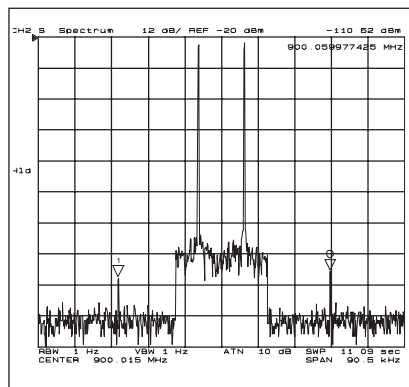

IMD measurement using List Sweep function

- See close-in signals using the 1 Hz RBW with a 3:1 shape factor.

Monitor close-in low level signals such as the 60-Hz power line sideband ripple shown here. You get excellent spectral resolution from digital RBW filters (4395A: all RBWs, 4396B: RBW ≤ 3 kHz) with a shape factor as steep as 3:1.

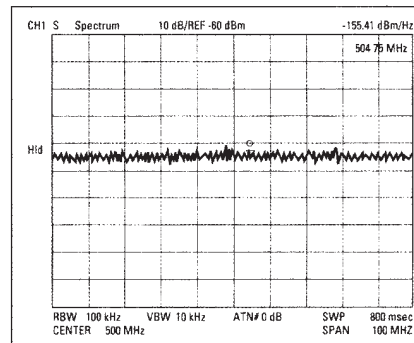
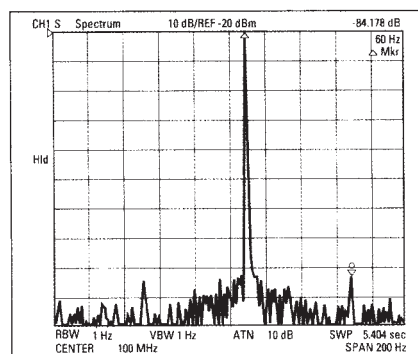

Measure noise precisely. The analyzer's low noise floor provides the sensitivity required for detecting low-level signals.

Perform accurate burst signal analysis with time-gating (Opt. 1D6). Digital video bandwidth smooths noise faster than analog spectrum analyzers.

Use these powerful spectrum analysis capabilities, combined with vector network analysis, for design and test in these applications:

- CATV
- GPS
- GSM
- HDTV
- VSAT
- VCR
- Optical Disk Drives
- Mobile Radio
- Cellular Communications

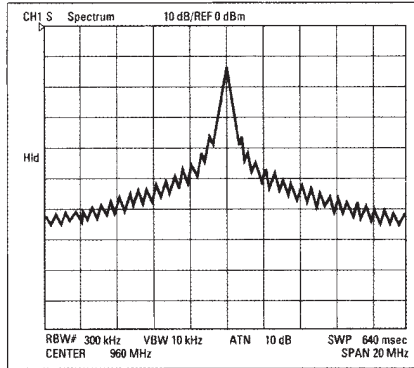

Frequency spectrum of a signal measured without time gating.

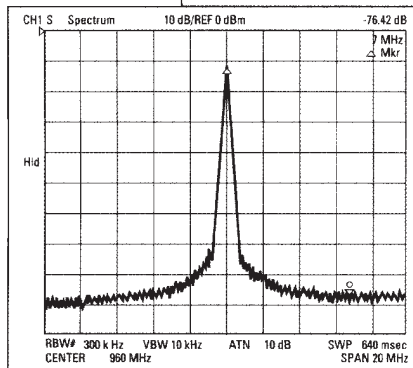
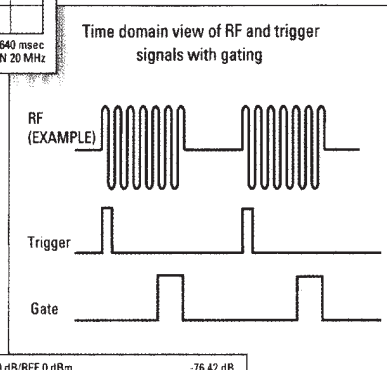

You can use time gating to accurately characterize burst-modulated signals used in data storage, television, and video equipment. Narrow gating (4395A: 6 μ s min. 4396B: 2 μ s min.) is ideal for testing disk drives.

Time gating (Opt. 1D6) lets you make measurements within the burst envelope.

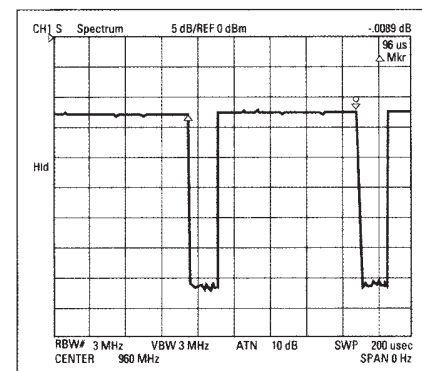

View the amplitude and modulation characteristics of a repetitive signal in Zero Span. The analyzer functions as a tunable receiver.

Accurate Direct Impedance Measurement

The Agilent 4395A/96B can perform direct impedance measurements with the addition of Option 010 and the Agilent 43961A RF impedance test kit. Covering from 100 kHz, impedance parameters $|Z|$, θ , C, L, Q, D and more are measured and displayed directly on the color TFT LCD display. For the Agilent 4395A, the Option 001 DC source is available to apply to the device, up to ± 40 V maximum.

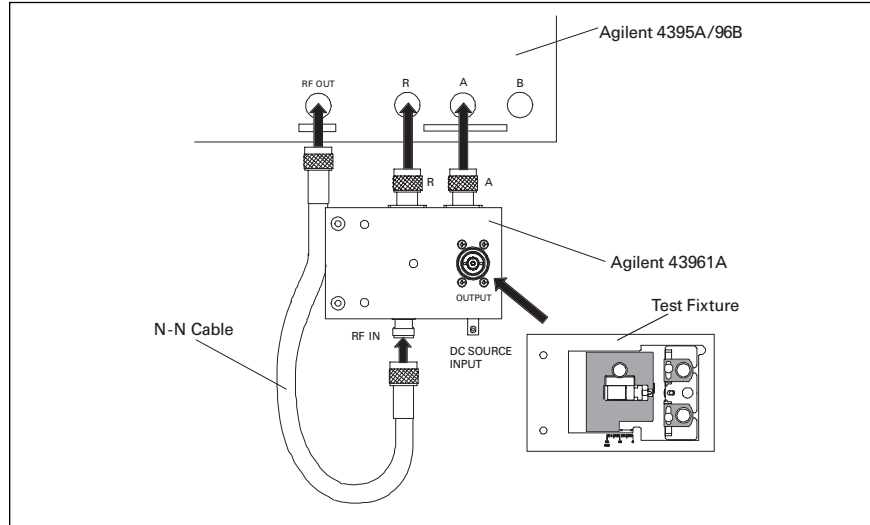

Connecting the Agilent 43961A to the Agilent 4395A/96B

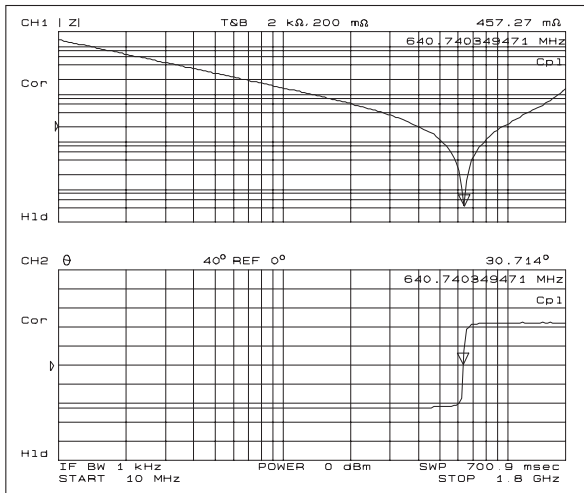

Two independent measurement channels and flexibility to impedance analysis

Direct Display of Impedance Data

The impedance measurement capability provides powerful display choices, allowing direct parameter versus frequency display. Measure and display capacitance, inductance, and impedance magnitude and phase, and more, as functions of frequency. In addition, a lumped equivalent circuit function aids component modeling and simulation.

Many Applicable Fixtures and Powerful Error Compensation

Many 7 mm connector type test fixtures can be used for the Agilent combination analyzer with Option 010 and the 43961A impedance test kit because the 43961A employs the 7 mm connector as the measurement port. So, you can select an appropriate fixture among them. The combination analyzer with Option 010 has the powerful OPEN/SHORT/LOAD compensation, and port extension compensation, which eliminate any errors introduced by the test fixture and allow accurate direct impedance measurements.

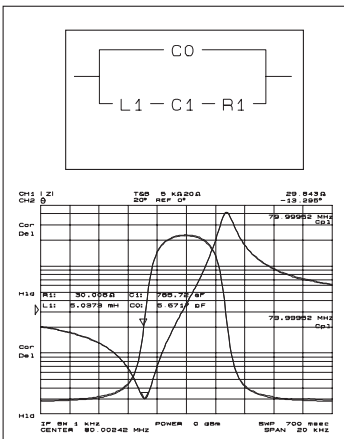

Equivalent Component Analysis (Resonator)

Easy Test Automation and System Integration

Maximize your throughput with the Agilent combination analyzer family. The analyzer is designed for high-volume testing:

- Fast vector network measurement speed.
- List sweep for fast testing at selected frequencies.
- Built-in IBASIC for test automation.
- Limit lines for pass/fail test.
- RAM disk with fast data access.
- Digital I/O port for controlling handlers or non-GPIB test equipment.
- VGA monitor output for an even larger display, improving productivity and reducing viewing fatigue.

Limit Functions

The built-in limit lines allow you to screen parts automatically and quickly.

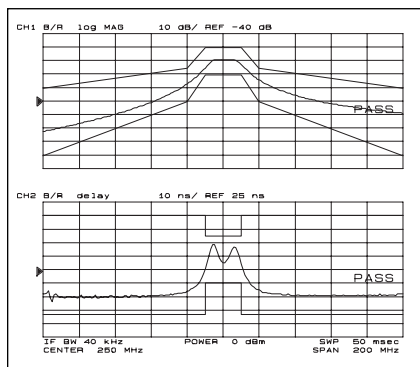

What is IBASIC?

IBASIC is a subset of the HT BASIC programming language. It is included in the standard Agilent 4395A/96B. IBASIC is extremely powerful, yet easy to use. You can automate testing, make customized programs, perform data analysis, and control external equipment with IBASIC. It supports an external keyboard for your convenience, and for effortless programming, it provides keystroke recording, which logs test code sequences as you push the buttons on the front panel.

You can control additional equipment without an external computer. By adding some external signal sources and RF switches, you can construct a cost-effective, high-speed test system for production.

The 4396B system (example shown in the block diagram) provides high-throughput, automated testing of gain, phase, and intermodulation distortion for components.

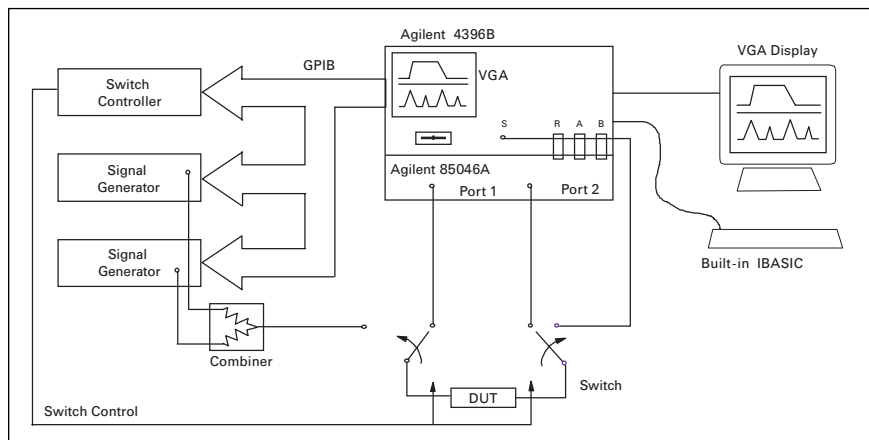

Integrate different instruments into a test system example with the Agilent 4396B

IBASIC program one key execution (Agilent 4395A only)

The Agilent 4395A has a unique one key execution function. It allows you to select your desired IBASIC program in RAM disk or Floppy Disk, and to run it by simply pressing the softkey. It's beneficial to undertake your first function in the Agilent 4395A.

Ordering Information

1. Agilent 4395A Network/ Spectrum/Impedance Analyzer

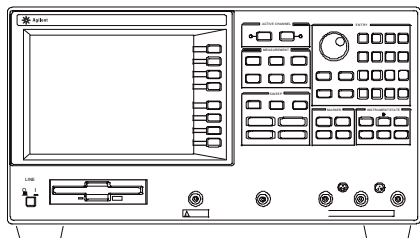

**Agilent 4395A Network/Spectrum/
Impedance Analyzer**

Options:

- 001** Add DC Source
- 010** Add Impedance Measurement Function
- 1A2** Delete keyboard
- 1D5** Add High Stability Frequency Reference
- 1D6** Add Time-Gated Spectrum Analysis
- 1D7** 50 Ω to 75 Ω Minimum Loss Pad
- ABA** English Localization
- UK6** Commercial cal. certificate w/test data
- 1CM** Rackmount Kit
- 1CN** Front Handle Kit
- 1CP** Rackmount and Front Handle Kit

2. Agilent 4396B Network/ Spectrum/Impedance Analyzer

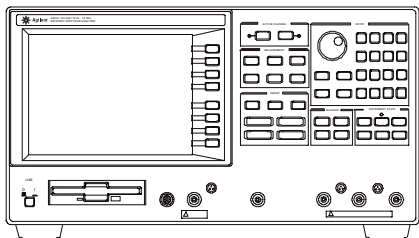

**Agilent 4396B Network/Spectrum/
Impedance Analyzer**

Options

- 010** Add Impedance Measurement Function
- 1A2** Delete keyboard
- 1D5** Add High Stability Frequency Reference
- 1D6** Add Time-Gated Spectrum Analysis
- 1D7** 50 Ω to 75 Ω Minimum Loss Pad
- ABA** English Localization
- UK6** Commercial cal. certificate w/test data
- 1CM** Rackmount Kit
- 1CN** Front Handle Kit
- 1CP** Rackmount and Front Handle Kit

3. Test Sets, Splitters, and Directional Bridges

S-parameter test sets allow both forward and reverse measurements with a single connection of your DUT.

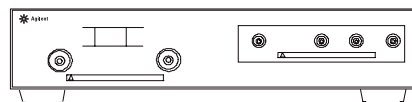

Agilent 85046A

Agilent 87511A—50 Ω S-parameter (100 kHz-500 MHz), 7mm test port¹

Agilent 87511B—75 Ω S-parameter (100 kHz-500 MHz), Type-N test port

Agilent 85046A—50 Ω S-parameter (300 kHz-3 GHz), 7mm test port¹

Agilent 85046B—75 Ω S-parameter (300 kHz-2 GHz), Type-N test port

1. To convert test port to Type-N, use Agilent 11524A 7 mm-to-N(f) adapter.

Transmission/reflection (T/R) test kits allow measurements in one direction only. Includes test set, short, load, and DUT return cable.

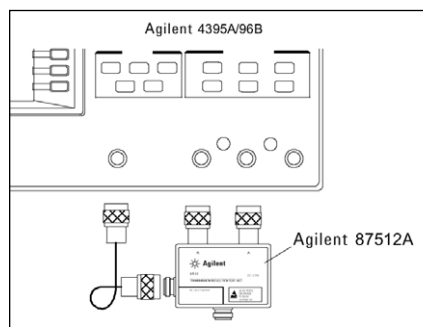

Agilent 87512A

Agilent 87512A 50 Ω (dc-2 GHz) Type-N connectors

Agilent 87512B 75 Ω (dc-2 GHz) Type-N connectors

These Type-N power splitters allow transmission measurements only in a single direction.

Agilent 11850C 50 Ω 3-way power splitter (dc-3 GHz)

Agilent 11850D 75 Ω 3-way power splitter (dc-2 GHz)

Agilent 11667A 50 Ω 2-way power splitter (dc-18 GHz)

These high-directivity RF bridges are designed for accurate reflection measurements and signal-leveling applications.

Agilent 86205A 50 Ω RF Bridge (300 kHz to 6 GHz)

Agilent 86207A 75 Ω RF Bridge (300 kHz to 3 GHz)

4. Calibration Kits

A complete line of kits make calibrating your analyzer fast and easy.

- Agilent 85031B** 50 Ω, 7 mm
- Agilent 85032B** 50 Ω, Type-N
- Agilent 85033D** 50 Ω, 3.5 mm
- Agilent 85036B** 75 Ω, Type-N

5. Accessory Kits

These kits furnish RF components generally required for use with test sets and splitters.

Agilent 11853A 50 Ω, Type-N short circuits and adapters

Agilent 11854A 50 Ω, Type-N to BNC adapters

Agilent 11855A 75 Ω, Type-N terminations and adapters

Agilent 11856A 75 Ω, Type-N to BNC adapters

6. Cable Kits

For reliable connections between the test set and the DUT.

Agilent 11851B 50 Ω Type-N RF cable kit (for Type-N splitters or T/R test sets)

Agilent 11857B 75 Ω Type-N test port return cables

Agilent 11857D 50 Ω 7 mm test port return cables

7. Probes

Extend the capabilities of the analyzer directly to your circuit.

Agilent 41800A 5 Hz to 500 MHz active probe

Agilent 41801A Probe power divider

Agilent 41802A 5 Hz to 100 MHz 1 MΩ Input Adapter

Agilent 54701A 2.5 GHz High-Impedance probe (requires Agilent 1743A Probe Offset and Power Control Module)

Agilent 85024A 300 MHz to 3 GHz High Frequency Probe

Agilent 1141A dc to 200 MHz Differential Probe

Agilent 11940A 9 kHz to 30 MHz Close-Field Probe Set

Agilent 11941A 30 MHz to 1 GHz Close-Field Probe Set

Agilent 11945A 9 kHz to 1 GHz Close-Field Probe Set

8. Impedance Test Kit

The Agilent 4395A/96B can perform direct impedance measurements with the addition of Option 010 and the Agilent 43961A RF impedance test kit. The Agilent 43961A includes a test adapter, an N(m)-N(m) cable, OPEN/SHORT/LOAD calibration standard, and carrying case.

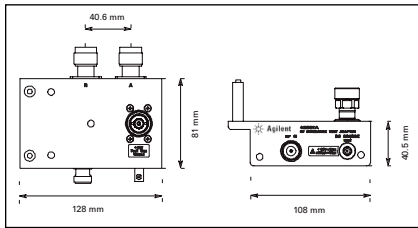

Agilent 43961A RF Impedance Test Kit

9. Test Fixtures for Impedance Measurement

Agilent 16191A Bottom electrode SMD test fixture (dc to 2 GHz)

Agilent 16192A Parallel electrode SMD test fixture (dc to 2 GHz)

Agilent 16197A Bottom electrode SMD test fixture (dc to 3 GHz)

Agilent 16194A High temperature component test fixture (dc to 2 GHz)

Agilent 16092A Spring clip test fixture (dc to 500 MHz)

Agilent 16093A Binding post test fixture (dc to 250 MHz)

Agilent 16093B Binding post test fixture (dc to 125 MHz)

Test Fixtures and DUT sizes

Agilent 16191A	Agilent 16192A	Agilent 16197A
L=2.0 - 12.0 mm	L=1.0 - 20.0 mm	L=0.6 - 3.2 mm

Agilent 16194A		
L=2.0 - 15.0 mm	L < 15 mm H < 4.5 mm	W=8.0 - 21.0 mm

General Characteristics

Agilent 4395A:

Remote programming interface: GPIB interface operates according to IEEE 488.1-1987 and IEEE 488.2-1987 and IEC 625 standards.

I/O Port: 8 bit I/O, 24 bit I/O

Printer: Centronics Parallel I/O Port (Agilent PCL3)

Temperature: Operating¹, 0 °C to 40 °C; storage, -20 °C to 60 °C

Humidity: Operating¹ 15% <RH <95%

Power: 100/120/220/240 V ±10%, 47 Hz to 63 Hz, 300 VA max.

Connectors: 50 Ω Type-N(f)

Probe power: +15 V @ 300 mA, -12.6 V @ 160 mA, GND

Display: 8.4 inch color TFT LCD

Weight: 21 kg (46 lb.) typical

Dimensions:

235 mm H × 425 mm W × 553 mm D (9.25 in. × 16.75 in. × 21.72 in.)

Agilent 4396B:

Remote programming interface: GPIB interface operates according to IEEE 488.1-1987 and IEEE 488.2-1987 and IEC 625 standards.

I/O Port: 8 bit I/O

Printer: Centronics Parallel I/O Port (Agilent PCL3)

Temperature: Operating¹, 0 °C to 40 °C; storage, -20 °C to 60 °C

Humidity: Operating¹ 15% <RH <95%

Power: 100/120/220/240 V ±10%, 47 Hz to 63 Hz, 300 VA max.

Connectors: 50 Ω Type-N(f)

Probe power: +15 V @ 300 mA, -12.6 V @ 160 mA, GND.

Display: 8.4 inch color TFT LCD

Weight: 21.5 kg (47 lb.) typical

Dimensions:

235 mm H × 425 mm W × 553 mm D (9.25 in. × 16.75 in. × 21.72 in.)

1. Disk drive operating region: 10 °C to 40 °C and 15% to 80% RH.

MS-DOS® is a registered trademark of Microsoft Corporation.

Agilent 4395A Accessories Selection Guide

		50 Ω			75 Ω		
		Trans.	T/R	S-para	Trans.	T/R	S-para
Power splitter	3-way	11850C			11850D		
	2-way	11667A					
Test set		87512A		87511A ^{1,2}	87512B		87511B ¹
		85046A ³			85046B ⁴		
Cal. kit	7 mm	85031B					
	N	85032B			85036B		
	3.5 mm	85033D					
Cable Kit		11851B		11857D	11857B		11857B
Acc. Kit	N	11853A			11855A		
	BNC	11854A			11856A		

1. 100 kHz to 500 Mhz.

2. 7 mm Test Port. Type-N is available as an option.

3. 300 kHz to 3 GHz. 7 mm Test Port. To convert to Type-N, use Agilent 11524A

7 mm-to-N(f) adapter.

4. 300 kHz to 4 GHz.

Agilent 4396B Accessories Selection Guide

		50 Ω			75 Ω		
		Trans.	T/R	S-para	Trans.	T/R	S-para
Power splitter		11850C			11850D		
		11667A					
Test set		87512A		85046A ¹	87512B		85046B
	7 mm	85031B					
Cal. kit	N	85032B			85036B		
	3.5 mm	85033D					
Cable Kit		11851B		11857D	11857B		11857B
Acc. Kit	N	11853A			11855A		
	BNC	11854A			11856A		

1. 7 mm test port. To convert to Type-N, use Agilent 11524A 7 mm-to-N(f) adapter.

For detailed specifications, refer to the Agilent 4395A Data Sheet (P/N 5965-9340E), or Agilent 4396B Data Sheet (P/N 5965-6311E).

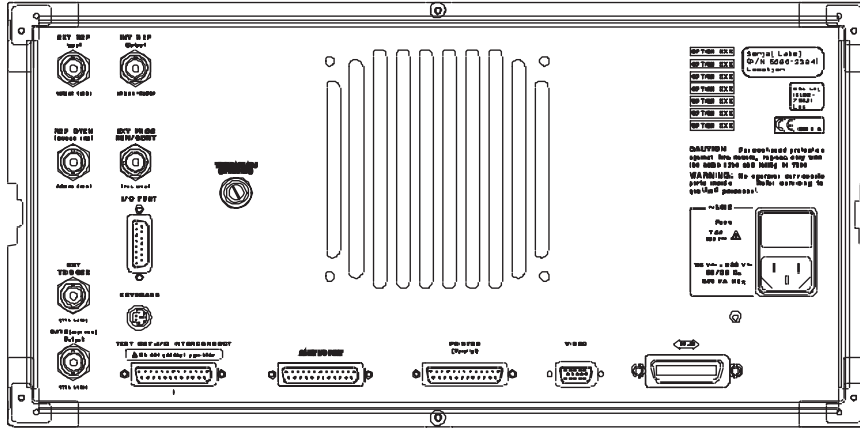

Agilent 4395A Rear Panel

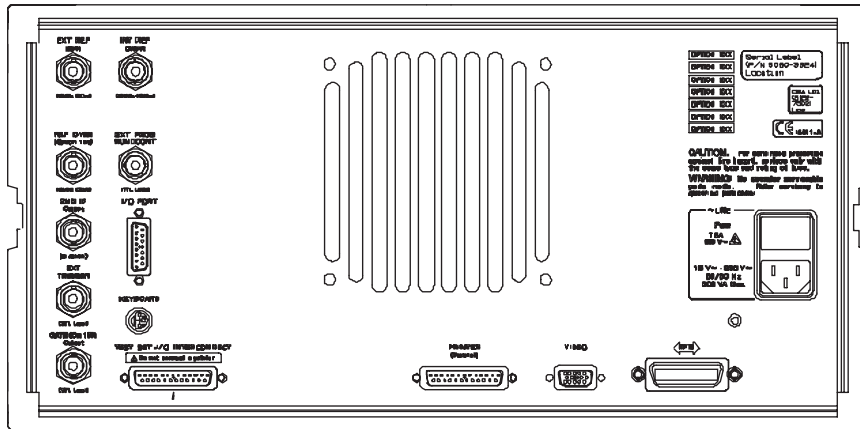

Agilent 4396B Rear Panel

Ryowa Electronics Co., Ltd. provides a fixture and software to evaluate thin film permeance with the Agilent 4395A (measurement parameters: complex permeability, loss coefficient, equivalent B-H loop, etc.). For further details, please contact the office as shown below:

Ryowa Electronics Co., Ltd.
 Head Office: 48 Minami Zaimoku-cho
 Wakabayashi-ku
 Sendai-city 984-0805 JAPAN
 Phone: (81) 22-266-4188
 Fax: (81) 22-266-4199



Permeance measurement system configuration with Agilent 4395A

Agilent Technologies' Test and Measurement Support, Services, and Assistance

Agilent Technologies aims to maximize the value you receive, while minimizing your risk and problems. We strive to ensure that you get the test and measurement capabilities you paid for and obtain the support you need. Our extensive support resources and services can help you choose the right Agilent products for your applications and apply them successfully. Every instrument and system we sell has a global warranty. Support is available for at least five years beyond the production life of the product. Two concepts underlie Agilent's overall support policy: "Our Promise" and "Your Advantage."

Our Promise

"Our Promise" means your Agilent test and measurement equipment will meet its advertised performance and functionality. When you are choosing new equipment, we will help you with product information, including realistic performance specifications and practical recommendations from experienced test engineers. When you use Agilent equipment, we can verify that it works properly, help with product operation, and provide basic measurement assistance for the use of specified capabilities, at no extra cost upon request. Many self-help tools are available.

Your Advantage

"Your Advantage" means that Agilent offers a wide range of additional expert test and measurement services, which you can purchase according to your unique technical and business needs. Solve problems efficiently and gain a competitive edge by contracting with us for calibration, extra-cost upgrades, out-of-warranty repairs, and on-site education and training, as well as design, system integration, project management, and other professional services. Experienced Agilent engineers and technicians worldwide can help you maximize your productivity, optimize the return on investment of your Agilent instruments and systems, and obtain dependable measurement accuracy for the life of those products.

Get assistance with all your test and measurement needs at:
www.agilent.com/find/assist

Product specifications and descriptions in this document subject to change without notice.

Copyright © 2000 Agilent Technologies
 Printed in U.S.A. 11/00
 5965-9374E